

Set Up Instructions

BLIMP CUBE

Step 1: Unpack hardware and assemble all poles together.

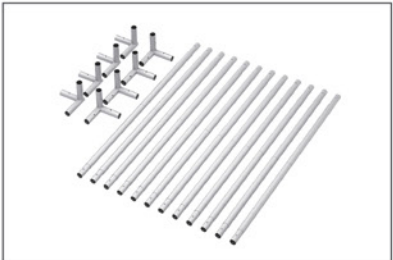

Step 2: Attach 4 corners to horizontal poles to create top and bottom squares. Face vertical pole attachment upwards.

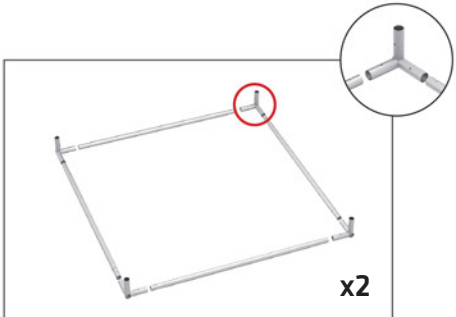

Step 3: Insert vertical poles into 4 corners.

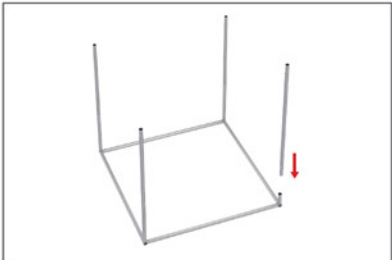

Step 4: Before attaching top square onto vertical poles, decide which hanging system you will be using - A or B.

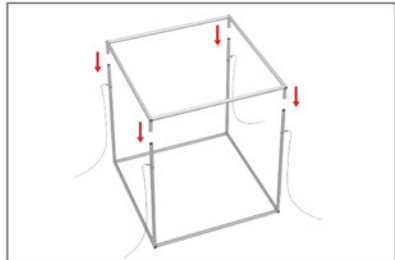

Step 5: Zip graphic onto frame. Position eyelets over top 4 corners to attach eyebolts.

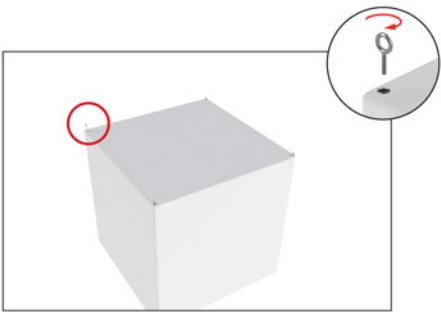

Step 6: Attach cables to eyebolts in the 4 corners with carabiners.

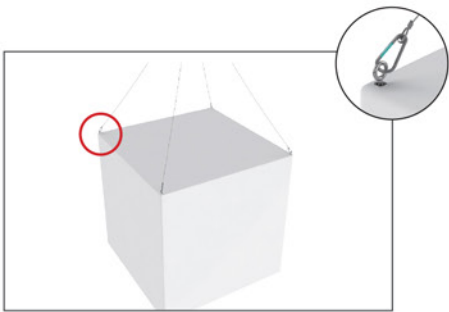

Step 7: Complete

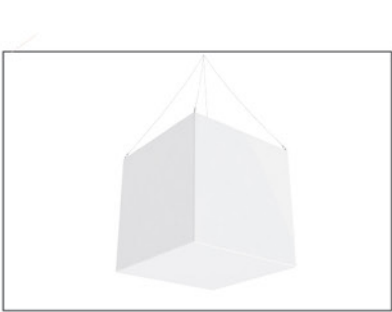

A Slide cable loop onto the end of corner before attaching.
B Screw eyebolts into corners and attach cables.

